

ILUMINOS STRIPE

- DE** Bedienungsanleitung
- EN** Operating instructions
- FR** Mode d'emploi
- NL** Handleiding
- IT** Istruzioni per l'uso
- ES** Instrucciones de uso



Manual Download

- DE** Besuchen Sie unsere Website über den folgenden QR Code oder Weblink um weitere Informationen zu diesem Produkt oder die verfügbaren Übersetzungen dieser Anleitung zu finden.
- EN** Visit our website via the following QR Code or web link to find further information on this product or the available translations of these instructions.
- FR** Si vous souhaitez obtenir plus d'informations concernant ce produit ou rechercher ce mode d'emploi en d'autres langues, rendez-vous sur notre site Internet en utilisant le code QR ou le lien correspondant.
- NL** Bezoek onze internetpagina via de volgende QR-code of weblink, voor meer informatie over dit product of de beschikbare vertalingen van deze gebruiksaanwijzing.
- IT** Desidera ricevere informazioni esaustive su questo prodotto in una lingua specifica? Venga a visitare il nostro sito Web al seguente link (codice QR Code) per conoscere le versioni disponibili.
- ES** ¿Desearía recibir unas instrucciones de uso completas sobre este producto en un idioma determinado? Entonces visite nuestra página web utilizando el siguiente enlace (código QR) para ver las versiones disponibles.
- DK** Ønsker du en udførlig vejledning til dette produkt på et bestemt sprog? Så besøg vores website ved hjælp af følgende link (QR-kode) for tilgængelige versioner.
- RU** Вам требуется подробная инструкция на это изделие на определенном языке? Проверьте наличие соответствующей версии инструкции, посетив наш сайт по этой ссылке (QR-код).



MANUAL DOWNLOAD:



www.bresser.de/P9082600



SERVICE AND WARRANTY:



www.bresser.de/warranty_terms

DE	Bedienungsanleitung	4
EN	Operating instructions	9
FR	Mode d'emploi	14
NL	Handleiding	19
IT	Istruzioni per l'uso	24
ES	Instrucciones de uso	29

DE Bedienungsanleitung

Allgemeine Informationen

 Lesen Sie vor der Benutzung des Geräts aufmerksam die Sicherheitshinweise und die Bedienungsanleitung. Bewahren Sie diese Bedienungsanleitung für die erneute Verwendung zu einem späteren Zeitpunkt auf. Bei Verkauf oder Weitergabe des Gerätes ist die Bedienungsanleitung an jeden nachfolgenden Besitzer/Benutzer des Produkts weiterzugeben.

Allgemeine Warnhinweise

- **BLENDGEFAHR!** Sorgen Sie dafür, dass Menschen und Tiere nicht in die Leuchte blicken. Durch die hohe Leuchtkraft können die Augen geblendet werden und Nachbilder entstehen. Diese Beeinträchtigung des Sehvermögens kann zu Unfällen führen.
- Verwenden Sie LED-Lampen nur in einem Abstand von mindestens 20 cm.
- Blicken Sie nicht für längere Zeit in das LED-Licht. Nicht bestimmungsgemäßer Gebrauch der Lampe kann zu Schäden der Augen führen. Es besteht **ERBLINDUNGSGEFAHR** durch Netzhautschädigung!
- **ERSTICKUNGSGEFAHR** – Verpackungsmaterialien (Plastiktüten, Gummibänder, etc.) von Kindern fernhalten! Dieses Produkt beinhaltet Kleinteile, die von Kindern verschluckt werden können! Es besteht **ERSTICKUNGSGEFAHR!**
- Dieses Gerät beinhaltet Elektronikteile, die über eine Stromquelle betrieben werden. Lassen Sie Kinder beim Umgang mit dem

Gerät nie unbeaufsichtigt! Die Nutzung darf nur, wie in der Anleitung beschrieben erfolgen, andernfalls besteht **GEFAHR** eines **STROMSCHLAGS!**

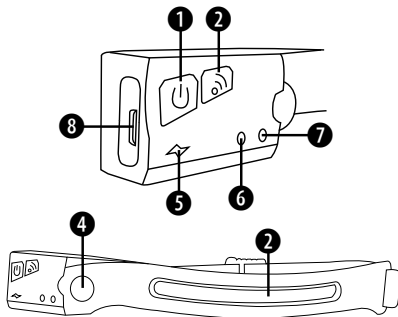

- **GEFAHR EINES STROMSCHLAGS** – Strom- und Verbindungskabel sowie Verlängerungen und Anschlussstücke niemals knicken, quetschen oder zerren. Schützen sie Kabel vor scharfen Kanten und Hitze. Überprüfen Sie das Gerät, die Kabel und Anschlüsse vor Inbetriebnahme auf Beschädigungen. Beschädigtes Gerät oder ein Gerät mit beschädigten stromführenden Teilen niemals in Betrieb nehmen! Beschädigte Teile müssen umgehend von einem autorisierten Service-Betrieb ausgetauscht werden.
- **GEFAHR** von Sachschäden! – Bauen Sie das Gerät nicht auseinander! Wenden Sie sich im Falle eines Defekts an Ihren Fachhändler. Er nimmt mit dem Service-Center Kontakt auf und kann das Gerät ggf. zwecks Reparatur einschicken.
- Gerät nicht kurzschließen oder ins Feuer werfen! Durch übermäßige Hitze und unsachgemäße Handhabung können Kurzschlüsse, Brände und sogar Explosionen ausgelöst werden!

Teileübersicht



- ❶ Ein-/Aushalter / Betriebsmodi
- ❷ IR-Sensortaste (Ein/Aus)
- ❸ LED-Streifen
- ❹ LED-Spot
- ❺ Betriebsanzeige
- ❻ Batterieanzeige
- ❼ IR-Sensor
- ❽ USB-C-Anschluss

Lieferumfang





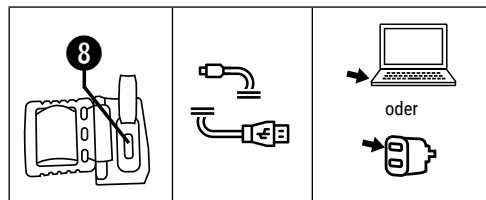

		
Stirnlampe	USB-C Kabel zum Aufladen	Stirnband



Aufladen über USB-C-Ladekabel

Die Batterieanzeige leuchtet rot wenn der Akku schwach ist und die Stirnlampe aufgeladen werden muss. Der USB-C Anschluss (8) ermöglicht das Laden des Akkus durch anschließen an einen PC oder einen anderen USB-Anschluss. Verbinde das USB-C-Ladekabel mit dem Anschluss an der Stirnlampe. Eine rote Lampe (6) leuchtet auf, wenn der Akku geladen wird.



Betriebsmodi ①

 Drücken	Funktion
	<ul style="list-style-type: none"> • Stirnlampe einschalten • LED-Streifen auf 100%
	<ul style="list-style-type: none"> • LED-Streifen auf 40%
	<ul style="list-style-type: none"> • LED-Spot auf 100%
	<ul style="list-style-type: none"> • LED-Spot auf 40%
	<ul style="list-style-type: none"> • Licht blinkt (SOS)
	<ul style="list-style-type: none"> • Stirnlampe ausschalten

 Drücken	Funktion
	<ul style="list-style-type: none"> • IR Sensor aktivieren
	<ul style="list-style-type: none"> • IR Sensor deaktivieren

IR-Sensor

Wählen Sie zuerst den gewünschten Betriebsmodus durch drücken der Taste Betriebsmodi (1). Aktivieren Sie nun den IR-Sensor Modus durch drücken der IR-Sensortaste (2). Wenn die Betriebsanzeige (5) rot/grün leuchtet ist der IR-Sensor Modus aktiv. Halten Sie Ihre Hand innerhalb von ca. 15 cm vor den IR-Sensor (7) an der Stirnlampe um das Licht ein- oder auszuschalten.

Stirnband

Die Lampe verfügt über ein flexibles Stirnband das dehnbar und anpassbar ist.

Technische Daten

Lichtquelle 1	LED-Streifen (flex COB)
Lichtquelle 2	LED-Spot
Helligkeitsstufen	100% / 40% / blinken
Batteriebetrieb	1x 1200 mAh Li-Po battery
Lichtfarbe	weiß
Helligkeit	LED-Streifen: 300 lm LED-Spot: 90 lm
Betriebszeit	LED-Streifen: 2.5h LED-Spot: 4h
Material	ABS + Silicone + EVA
Maße	34x3,2x1,6 cm (LxBxH)
Gewicht	69 g

HINWEISE zur Reinigung

- Trennen Sie das Gerät vor der Reinigung von der Stromquelle!
- Reinigen Sie das Gerät nur äußerlich mit einem trockenen Tuch. Benutzen Sie keine Reinigungsflüssigkeit, um Schäden an der Elektronik zu vermeiden.

EG-Konformitätserklärung

CE Eine „Konformitätserklärung“ in Übereinstimmung mit den anwendbaren Richtlinien und entsprechenden Normen ist von der Bresser GmbH erstellt worden. Der vollständige Text der EG-Konformitätserklärung ist unter der folgenden Internetadresse verfügbar:

www.bresser.de/download/9082600/CE/9082600_CE.pdf

ENTSORGUNG



Entsorgen Sie die Verpackungsmaterialien sortenrein. Informationen zur ordnungsgemäßen Entsorgung erhalten Sie beim kommunalen Entsorgungsdienstleister oder Umweltamt.



Werfen Sie Elektrogeräte nicht in den Hausmüll! Gemäß der Europäischen Richtlinie 2002/96/EG über Elektro- und Elektronik-Altgeräte und deren Umsetzung in nationales Recht müssen verbrauchte Elektrogeräte getrennt gesammelt und einer umweltgerechten Wiederverwertung zugeführt werden. Entladene Altbatterien und Akkus müssen vom Verbraucher in Batteriesammelgefäßen entsorgt werden. Informationen zur Entsorgung alter Geräte oder Batterien, die nach dem 01.06.2006 produziert wurden, erfahren Sie beim kommunalen Entsorgungsdienstleister oder Umweltamt.

 Batterien und Akkus dürfen nicht im Hausmüll entsorgt werden, sondern Sie sind zur Rückgabe gebrauchter Batterien und Akkus gesetzlich verpflichtet. Sie können die Batterien nach Gebrauch entweder in unserer Verkaufsstelle oder in unmittelbarer Nähe (z.B. im Handel oder in kommunalen Sammelstellen) unentgeltlich zurückgeben.

Batterien und Akkus sind mit einer durchgekreuzten Mülltonne sowie dem chemischen Symbol des Schadstoffes bezeichnet.



Cd¹



Hg²



Pb³

¹ Batterie enthält Cadmium

² Batterie enthält Quecksilber

³ Batterie enthält Blei

Garantie & Service

Die reguläre Garantiezeit beträgt 5 Jahre und beginnt am Tag des Kaufs. Die vollständigen Garantiebedingungen und Serviceleistungen können Sie unter www.bresser.de/garantiebedingungen einsehen.

EN Operating instructions

General Information

Please read the safety instructions and the operating instructions carefully before use. Keep these instructions for renewed use at a later date. When the device is sold or given to someone else, the instruction manual must be provided to the new owner/user of the product.

General Warnings

- RISK of GLARE! Make sure people and animals do not stare into the light. Due to the high power of illumination, your eyes can be glared or after-images may be achieved. This visual impairment can cause accidents.
- Use LED lamps only at a distance of at least 20 cm.
- Do not look into the LED light for a long time. Improper use of the flashlight can cause damage to the eyes. There is a DANGER OF BLINDNESS by retinal damage!
- Risk of choking – Keep packaging material, like plastic bags and rubber bands, out of the reach of children, as these materials pose a choking hazard. This product contains small parts that could be swallowed by children.
- This device contains electronic components that operate via a power source. Children should only use the device under adult supervision. Only use the device as described in the manual; otherwise, you run the risk of an electric shock.

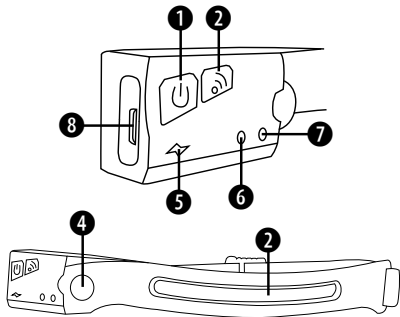

- Risk of electric shock – Never bend, pinch or pull the power and connecting cables, extensions and adapters. Protect the cables from sharp edges and heat. Before operating, check the device, cables and connections for damage. Never use a damaged unit or a unit with damaged power cables. Damaged parts must be exchanged immediately by an authorised service centre.
- Risk of property damage! – Do not disassemble the device. In the event of a defect, please contact your dealer. The dealer will contact the Service Centre and can send the device in to be repaired, if necessary.
- Do not expose the device to high temperatures. Do not short-circuit the device or throw them into a fire. Excessive heat or improper handling could trigger a short-circuit, a fire or an explosion.

Parts overview



- ❶ On/Off button, Operating modes
- ❷ IR Sensor button (On/Off)
- ❸ LED Stripe
- ❹ LED Spot
- ❺ Operation indicator
- ❻ Battery indicator
- ❼ IR-Sensor
- ❽ USB-C port

Scope of delivery





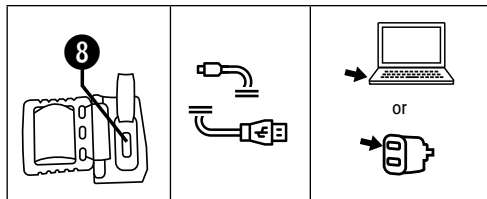

		
Headlamp	USB-C charging cable	Headband



Charging via USB-C charging cable

The battery indicator lights up red when the battery is low and the Headlamp needs to be charged. The USB-C port (8) allows you to charge the battery by connecting it to a PC or other USB port. Connect the USB-C charging cable to the port on the headlamp. A red lamp (6) lights up when the battery is being charged.



Operating modes ①

 Press	Function
	<ul style="list-style-type: none"> • Turn on the Headlamp • LED Stripe at 100%
	<ul style="list-style-type: none"> • LED Stripe at 40%
	<ul style="list-style-type: none"> • LED Spot at 100%
	<ul style="list-style-type: none"> • LED Spot at 40%
	<ul style="list-style-type: none"> • Light flashes (SOS)
	<ul style="list-style-type: none"> • Turn off the Headlamp

 Press	Function
	<ul style="list-style-type: none"> • Activate IR Sensor
	<ul style="list-style-type: none"> • Deactivate IR Sensor

IR-Sensor

First select the desired operating mode by pressing the operating modes button (1). Now activate the IR sensor mode by pressing the IR Sensor button (2). When the operation indicator (5) lights up red/green, the IR sensor mode is active. Hold your hand within approx. 15 cm in front of the IR Sensor (7) on the headlamp to switch the light on or off.

Head band

The lamp has a flexible headband that is stretchable and adjustable.

Technical data

Light source 1	LED Stripe (flex COB)
Light source 2	LED Spot
Brightness levels	100% / 40% / flashes
Battery operation	1x 1200 mAh Li-Po battery
Light colour	white
Brightness	LED Stripe: 300 lm LED Spot: 90 lm
Operating time	LED Stripe: 2.5h LED Spot: 4h
Material	ABS + Silicone + EVA
Dimensions	34x3.2x1.6 cm (LxWxH)
Weight	69 g

Notes on cleaning

- Before cleaning the device, disconnect it from the power supply!
- Only use a dry cloth to clean the exterior of the device. To avoid damaging the electronics, do not use any cleaning fluid.

EC Declaration of Conformity

 Bresser GmbH has issued a "Declaration of Conformity" in accordance with applicable guidelines and corresponding standards. The full text of the EU declaration of conformity is available at the following internet address:
www.bresser.de/download/9082600/CE/9082600_CE.pdf

UKCA Declaration of Conformity

 Bresser GmbH has issued a „Declaration of Conformity“ in accordance with applicable guidelines and corresponding standards. The full text of the UKCA declaration of conformity is available at the following internet address:
www.bresser.de/download/9082600/UKCA/9082600_UKCA.pdf

Bresser UK Ltd. • Suite 3G, Eden House, Enterprise Way,
Edenbridge, Kent TN8 6HF, UK

Disposal

 Dispose of the packaging materials properly, according to their type, such as paper or cardboard. Contact your local waste-disposal service or environmental authority for information on the proper disposal.



Do not dispose of electronic devices in the household garbage!

As per Directive 2002/96/EC of the European Parliament on waste electrical and electronic equipment and its adaptation into German law, used electronic devices must be collected separately and recycled in an environmentally friendly manner. Empty, old batteries must be disposed of at battery collection points by the consumer. You can find out more information about the disposal of devices or batteries produced after 6 January 2006 from your local waste-disposal service or environmental authority.



In accordance with the regulations concerning batteries and rechargeable batteries, disposing of them in the normal household waste is explicitly forbidden. Please make sure to dispose of your used batteries as required by law – at a local collection point or in the retail market. Disposal in domestic waste violates the Battery Directive.

Batteries that contain toxins are marked with a sign and a chemical symbol.

Cd¹Hg²Pb³

¹ battery contains cadmium

² battery contains mercury

³ battery contains lead

Warranty & Service

The regular guarantee period is 5 years and begins on the day of purchase. You can consult the full guarantee terms and details of our services at: www.bresser.de/warranty_terms.

FR Mode d'emploi

Informations générales



Avant d'utiliser l'appareil, veuillez lire attentivement les consignes de sécurité et le mode d'emploi. Conservez celui-ci afin de pouvoir le réutiliser ultérieurement le cas échéant. En cas de revente ou de cession de l'appareil, le mode d'emploi doit être remis à tout propriétaire ou utilisateur suivant du produit.



Consignes générales de sécurité



- **RISQUE D'ÉBLOUISSEMENT !** Assurez-vous que ni les personnes ni les animaux ne regardent directement la lumière. L'éclat de la lumière est puissant et il peut éblouir les yeux avec apparition d'images rémanentes. Ces troubles de la vision peuvent provoquer des accidents.
- Use LED lamps only at a distance of at least 20 cm.
- Ne regardez pas longtemps la lumière directe de la LED. Une mauvaise utilisation de la lampe de poche peut endommager les yeux. **RISQUE DE CÉCITÉ** par lésion de la rétine !
- **RISQUE D'ÉTOUFFEMENT** – Ce produit contient des petites pièces, qui pourraient être avalées par des enfants. Il y a un **RISQUE D'ÉTOUFFEMENT**.
- Cet appareil contient des pièces électroniques raccordées à une source d'alimentation électrique. Ne jamais laisser les enfants manipuler l'appareil sans surveillance ! L'utilisation de l'appareil doit se faire exclusivement comme décrit dans ce manuel, faute de quoi un **RISQUE D'ELECTROCUTION** peut exister !

- **RISQUE D'ELECTROCUTION !** – Les câbles électriques sous tensions ainsi que les rallonges et les cosses ne doivent pas subir de forces de torsions ou de traction, être coincés ou écrasés. Protégez les câbles des objets tranchants et de la chaleur. Vérifiez l'appareil, les câbles et les raccordements avant de les mettre en service pour vous assurer qu'ils ne soient pas endommagés. Aucun appareil endommagé ou dont les pièces sous tensions sont endommagées ne doit mis en service ! Les pièces dégradées doivent être remplacés par les professionnels de maintenance compétents dans les meilleurs délais.
- **RISQUE de dommages matériels !** – Ne pas démonter l'appareil ! En cas de défaut, veuillez vous adresser à votre revendeur spécialisé. Celui-ci prendra contact avec le service client pour, éventuellement, envoyer l'appareil en réparation.
- L'appareil et les batteries ne doivent être court-circuités ou jetés dans le feu ! Une chaleur excessive ou une utilisation inappropriée peuvent provoquer des courts-circuits, des incendies, voire même des explosions !

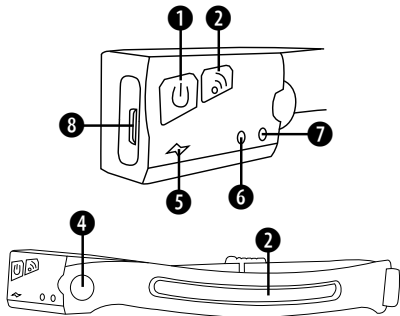
Aperçu des pièces



- ❶ Bouton marche/arrêt, Modes de fonctionnement
- ❷ Bouton du capteur infrarouge (Activé/Désactivé)
- ❸ Bande LED
- ❹ Spot LED
- ❺ Indicateur de fonctionnement
- ❻ Indicateur de batterie
- ❼ Capteur IR
- ❽ Port USB-C





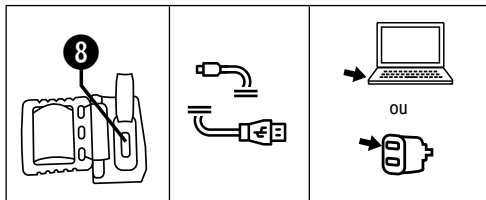

		
Lampe frontale	Câble de chargement USB-C	Bandeau



Chargement via un câble de chargement USB-C

Le port USB-C vous permet de charger la batterie en la connectant à un PC ou à un autre port USB-C. Un voyant rouge clignote lorsque la batterie est en charge. Un voyant rouge (6) s'allume lorsque la batterie est en charge.



Modes de fonctionnement ①

 presse	Une fonction
	<ul style="list-style-type: none"> • Allumez la lampe frontale • Bande LED à 100 %
	<ul style="list-style-type: none"> • Bande LED à 40 %
	<ul style="list-style-type: none"> • Spot LED à 100 %
	<ul style="list-style-type: none"> • Spot LED à 40 %
	<ul style="list-style-type: none"> • La lumière clignote (SOS)
	<ul style="list-style-type: none"> • Éteignez la lampe frontale

 presse	Une fonction
	<ul style="list-style-type: none"> • Activer le capteur infrarouge
	<ul style="list-style-type: none"> • Désactiver le capteur infrarouge

Capteur IR

Sélectionnez d'abord le mode de fonctionnement souhaité en appuyant sur le bouton des modes de fonctionnement (1). Activez maintenant le mode capteur IR en appuyant sur le bouton Capteur IR (2). Lorsque l'indicateur de fonctionnement (5) s'allume en rouge/vert, le mode capteur IR est actif. Tenez votre main dans env. 15 cm devant le Capteur IR (7) sur la lampe frontale pour allumer ou éteindre la lumière.

Bandeau

La lampe a un bandeau flexible qui est extensible et réglable.

Données techniques

Source lumineuse 1	LED Bande (flex COB)
Source lumineuse 2	LED Spot
Luminosité	niveaux 100% / 40% / clignote
Fonctionnement sur batterie	1x batterie Li-Po 1200 mAh
Couleur de la lumière	blanc
Luminosité	Bande LED : 300 lm Spot LED : 90 lm
Durée de fonctionnement	Bande LED : 2,5h Spot LED : 4h
Material	ABS + Silicone + EVA
Dimensions	34x3.2x1.6 cm (LxlxH)
Poids	69 g

REMARQUE concernant le nettoyage

- Avant de nettoyer l'appareil, veuillez le couper de son alimentation électrique !
- Ne nettoyez l'appareil que de l'extérieur en utilisant un chiffon sec. Ne pas utiliser de liquides de nettoyage, afin d'éviter d'endommager les parties électroniques.

Déclaration de conformité CE



Bresser GmbH a émis une « déclaration de conformité » conformément aux lignes directrices applicables et aux normes correspondantes. Le texte complet de la déclaration UE de conformité est disponible à l'adresse internet suivante: www.bresser.de/download/9082600/CE/9082600_CE.pdf

ELIMINATION



Éliminez l'emballage en triant les matériaux. Pour plus d'informations concernant les règles applicables en matière d'élimination de ce type de produits, veuillez vous adresser aux services communaux en charge de la gestion des déchets ou de l'environnement.



Ne jamais éliminer les appareils électriques avec les ordures ménagères !

Conformément à la directive européenne 2002/96/CE sur les appareils électriques et électroniques et ses transpositions aux plans nationaux, les appareils électriques usés doivent être collectés séparément et être recyclés dans le respect des réglementations en vigueur en matière de protection de l'environnement. Les batteries déchargées et les accumulateurs usés doivent être apportés par leurs utilisateurs dans les points de collecte prévus à cet effet. Pour plus d'informations concernant les règles applicables en matière d'élimination des batteries produites après la date du 01.06.2006, veuillez vous adresser aux services communaux en charge de la gestion des déchets ou de l'environnement.

 En conformité avec les règlements concernant les piles et les piles rechargeables, jeter ces produits avec les déchets ménagers normaux est strictement interdit. Veuillez à bien déposer vos piles usagées dans des lieux prévus à cet effet par la Loi, comme un point de collecte locale ou dans un magasin de détail (une élimination de ces produits avec les déchets domestiques constituerait une violation des directives sur les piles et batteries).

Les piles qui contiennent des toxines sont marquées avec un signe et un symbole chimique.



Cd¹



Hg²



Pb³

1 pile contenant du cadmium

2 pile contenant du mercure

3 pile contenant du plomb

Garantie et Service

La durée normale de la garantie est de 5 ans à compter du jour de l'achat. Vous pouvez consulter l'intégralité des conditions de garantie et les prestations de service sur www.bresser.de/warranty_terms.

NL Handleiding

Algemene informatie



Deze gebruiksaanwijzing maakt deel uit van het apparaat. Lees vóór het eerste gebruik van het apparaat de veiligheidsinstructies en de gebruiksaanwijzing aandachtig door. Bewaar deze gebruiksaanwijzing voor later gebruik. Wanneer het apparaat wordt verkocht of doorgegeven, dient de gebruiksaanwijzing aan de volgende eigenaar / gebruiker van het product te worden overgedragen.



Algemene waarschuwingen

- GEVAAR! Zorg ervoor dat mensen en dieren niet in de lamp kijken. De hoge lichtsterkte kan de ogen verblinden en nabeelden veroorzaken. Deze verslechtering van het gezichtsvermogen kan leiden tot ongelukken.
- Gebruik LED-lampen alleen op een afstand van minimaal 20 cm.
- Kijk niet te lang in het LED-licht. Onjuist gebruik van de zaklamp kan schade aan de ogen veroorzaken. Er is gevaar voor blindheid door netvliesbeschadiging!
- VERSTIKKINGSGEVAAR! – Verpakkingsmaterialen (Plastic zakken, elastiekjes, etc.) uit de buurt van kinderen houden! Er bestaat VERSTIKKINGSGEVAAR!
- Dit toestel bevat elektronische onderdelen die door een elektrische bron worden gevoed. Houd kinderen bij het gebruiken van dit toestel altijd onder toezicht! Het toestel mag alleen gebruikt

worden zoals in de handleiding wordt beschreven, anders bestaat er GEVAAR op een STROOMSTOOT!

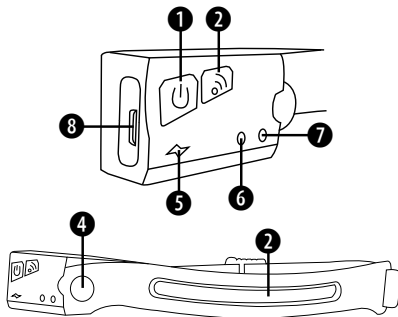

- GEVAAR VOOR ELEKTRISCHE SCHOK! – Aan stroom- en verbindingkabels, zoals verlengsnoeren en aansluitelementen mag niet worden getrokken, ze mogen niet worden geknikt of samen gedrukt. Bescherm de kabel voor scherpe randen en overmatige hitte. Controleer het apparaat, de kabels en aansluitingen op beschadigingen voordat u deze in gebruik neemt. Neem beschadigde apparatuur of een apparaat met beschadigde spanningvoerende onderdelen in geen geval in gebruik! Beschadigde onderdelen moeten direct door een bevoegd servicebedrijf worden vervangen.
- GEVAAR voor schade aan voorwerpen! – Neem het toestel niet uit elkaar! Neem bij defecten a.u.b. contact op met de verkoper. Deze zal contact opnemen met een servicecenter en kan het toestel indien nodig voor reparatie terugsturen.
- Sluit het apparaat niet kort en gooi het niet in het vuur! Te hoge temperaturen en ondeskundig gebruik kunnen leiden tot kortsluitingen, branden en zelfs explosies!

Overzicht van de onderdelen



- ❶ Aan/uit-knop, bedrijfsmodi
- ❷ IR-sensorknop (Aan/Uit)
- ❸ LED Stripe
- ❹ LED Spot
- ❺ Werkingsindicator
- ❻ Batterij-indicator
- ❼ IR-Sensor
- ❽ USB-C-poort

Leveringsomvang





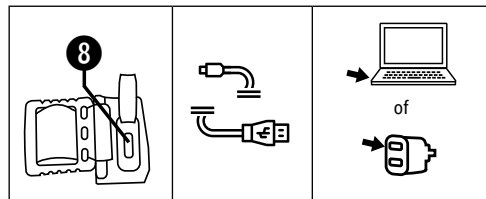

		
Hoofdlamp	USB-C- oplaadkabel	Hoofdband



Opladen via USB-C-laadkabel

Met de USB-C-poort kunt u de batterij opladen door deze aan te sluiten op een PC of andere USB-C-poort. Een rood lampje knippert wanneer de batterij wordt opgeladen. Een rood lampje (6) brandt wanneer de batterij wordt opgeladen.



Bedrijfsmodi 1

 Druk op	Functie
	<ul style="list-style-type: none"> • Zet de koplamp aan • LED Stripe op 100%
	<ul style="list-style-type: none"> • LED Stripe op 40%
	<ul style="list-style-type: none"> • LED Spot op 100%
	<ul style="list-style-type: none"> • LED Spot op 40%
	<ul style="list-style-type: none"> • Lichtflitsen (SOS)
	<ul style="list-style-type: none"> • Schakel de hoofdlamp uit

 Druk op	Functie
	<ul style="list-style-type: none"> • IR-sensor activeren
	<ul style="list-style-type: none"> • Deactiveer IR-sensor

IR-Sensor

Selecteer eerst de gewenste bedrijfsmodus door op de bedrijfsmodusknop (1) te drukken. Activeer nu de IR-sensor modus door op de IR-sensorknop (2) te drukken. Wanneer de bedrijfsindicator (5) rood/groen oplicht, is de IR-sensor modus actief. Houd uw hand binnen ca. 15 cm voor de IR Sensor (7) op de hoofdlamp om het licht aan of uit te schakelen.

Hoofdband

De lamp heeft een flexibele hoofdband die rekbaar en verstelbaar is.

Technische gegevens

Lichtbron 1	LED Stripe (flex COB)
Lichtbron 2	LED Spot
Helderheidsniveaus	100% / 40% / flitsen
Werking op batterijen	1x 1200 mAh Li-Po batterij
Kleur verlichting	wit
Helderheid	LED Stripe: 300 lm LED Spot: 90 lm
Werkingsduur	LED Stripe: 2.5h LED Spot: 4h
Materiaal	ABS + Silicone + EVA
Afmetingen	34x3.2x1.6 cm (LxBxH)
Gewicht	69 g

TIPS voor reiniging

- Koppel het toestel los van de stroomvoorziening voordat u het reinigt!
- Reinig het toestel alleen uitwendig met een droge doek. Gebruik geen vloeistoffen, om schade aan de elektronica te vermeiden.

EG-conformiteitsverklaring

 Een "conformiteitsverklaring" in overeenstemming met de van toepassing zijnde richtlijnen en overeenkomstige normen is door Bresser GmbH afgegeven. Il testo completo della dichiarazione di conformità UE è disponibile al seguente indirizzo Internet:
www.bresser.de/download/9082600/CE/9082600_CE.pdf

AFVAL



Scheid het verpakkingsmateriaal voordat u het weggooit. Informatie over het correct scheiden en weggooien van afval kunt u bij uw gemeentelijke milieudienst inwinnen.



Gooi elektronische apparaten niet bij het huisvuil! Volgens de Europese richtlijn 2002/96/EG over elektrische en elektronische apparaten en de toepassing hiervan in nationale wetten moeten afgedankte elektrische apparaten gescheiden worden ingezameld en op milieuvriendelijke wijze worden afgevoerd. Lege batterijen en accu's moeten door de gebruiker in een batterijenverzamelbak worden weggegooid. Informatie over het weggooien van oude apparaten en batterijen, die na 01-06-2006 zijn geproduceerd, kunt u bij uw gemeentelijke milieudienst inwinnen.



Batterijen en accu's mogen niet worden weggegooid in de vuilnisbak. U bent wettelijk verplicht om gebruikte batterijen in te leveren. U kunt de gebruikte batterijen in onze winkel of in de onmiddellijke omgeving, bijv. bij gemeentelijke inzamelpunten gra-

tis inleveren.

Batterijen en accu's zijn gemarkeerd met een doorgestreepte vuilnisbak en het chemische symbool van de verontreinigende stoffen: „Cd“ staat voor Cadmium, „Hg“ staat voor Kwik en „Pb“ voor Lood.



Cd¹



Hg²



Pb³

¹ batterij bevat cadmium

² batterij bevat kwik

³ accu bevat lood

Garantie & Service

De reguliere garantieperiode bedraagt 5 jaar en begint op de dag van aankoop. De volledige garantievoorwaarden en servicediensten kunt u bekijken op www.bresser.de/warranty_terms.

IT Istruzioni per l'uso

Informazioni generali



Questo manuale d'uso va considerato parte integrante dell'apparecchio. Prima di usare l'apparecchio, leggere con attenzione le indicazioni di sicurezza e il manuale d'uso. Conservare il manuale d'uso per poterlo utilizzare di nuovo in un secondo momento. Se si vende o si cede l'apparecchio, consegnare il manuale d'uso ad ogni successivo possessore/utilizzatore del prodotto.



Avvertenze di sicurezza generali

- **PERICOLO DI ABBAGLIAMENTO!**

Accertarsi che le persone e gli animali non fissino la luce. L'elevata intensità luminosa può abbagliare e causare un abbagliamento persistente. La compromissione della capacità visiva può causare incidenti.

- Utilizzare lampade a LED solo ad una distanza di almeno 20 cm.
- Non guardare a lungo la luce LED. Un uso improprio può danneggiare gli occhi. **PERICOLO DI ACCECAMENTO** a seguito di un danneggiamento della retina!
- **PERICOLO DI SOFFOCAMENTO!** – Tenere i materiali di imballaggio (sacchetti di plastica, elastici, ecc.) fuori dalla portata dei bambini! **PERICOLO DI SOFFOCAMENTO!**
- Questo apparecchio contiene componenti elettronici azionati da una sorgente di corrente. Non consentire ai bambini di utilizzare l'apparecchio senza supervisione! L'utilizzo deve avvenire soltanto confor-

memente a quanto descritto nella guida, in caso contrario esiste il **PERICOLO** di **SCOSSA ELETTRICA!**

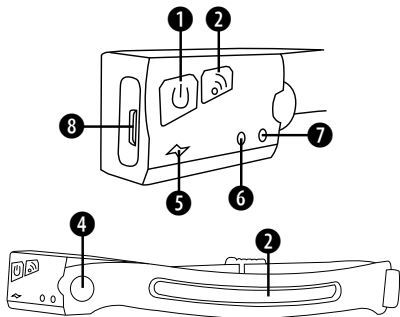

- **RISCHIO DI FOLGORAZIONE!** – Non piegare, schiacciare o tirare i cavi di alimentazione e di collegamento, le prolunghe e i connettori. Proteggere i cavi dagli spigoli appuntiti e dal calore. Prima dell'uso accertarsi che l'apparecchio, i cavi e i connettori non siano danneggiati. Mai mettere in funzione un apparecchio danneggiato o un apparecchio con componenti conduttori danneggiati. I componenti danneggiati devono essere subito sostituiti da un servizio di assistenza autorizzato.
- **PERICOLO di danni materiali!** – Non smontare l'apparecchio! In caso di guasto, rivolgersi al proprio rivenditore specializzato. Egli provvederà a contattare il centro di assistenza e se necessario a spedire l'apparecchio in riparazione.
- Non cortocircuitare o buttare nel fuoco l'apparecchio! Un surriscaldamento oppure un utilizzo non conforme può provocare cortocircuiti, incendi e persino esplosioni!

Panoramica dei componenti



- ❶ Interruttore ON/OFF / modalità di funzionamento
- ❷ Tasto per sensori IR (on/off)
- ❸ Striscia a LED
- ❹ Spot a LED
- ❺ Visualizzazione del funzionamento
- ❻ Indicatore della batteria
- ❼ Sensore IR
- ❽ Porta USB-C

Leveringsomvang





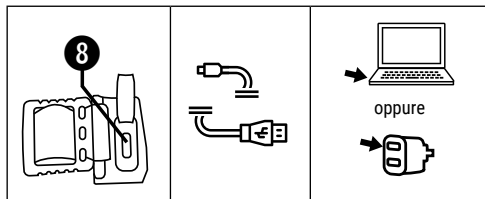

		
Lampada frontale	Cavo di ricarica USB-C	Fascia frontale

Ricarica tramite cavo USB-C

La porta USB-C permette di ricaricare la batteria collegando la lampada al PC o a un'altra porta USB-C. Quando la batteria è in carica, una spia rossa lampeggia. Quando si carica la batteria si accende una luce rossa (6).



Modalità d'uso ①

 Premere	Funzione
	<ul style="list-style-type: none"> • Accendere la lampada frontale • Striscia a LED al 100%
	<ul style="list-style-type: none"> • Striscia a LED al 40%
	<ul style="list-style-type: none"> • Spot a LED al 100%
	<ul style="list-style-type: none"> • Spot a LED al 40%
	<ul style="list-style-type: none"> • La luce lampeggia (SOS)
	<ul style="list-style-type: none"> • Spegnerne la lampada frontale

 Premere	Funzione
	<ul style="list-style-type: none"> • Attivare il sensore IR
	<ul style="list-style-type: none"> • Disattivare il sensore IR

Sensore IR

Prima di tutto, selezionare la modalità di funzionamento desiderata premendo il tasto Modalità di funzionamento (1). Ora attivare la modalità sensore IR premendo il tasto Sensore IR (2). Se l'indicatore di funzionamento (5) lampeggia rosso/verde, la modalità sensore IR è attiva. Tenere la mano a max. 15 cm davanti al sensore IR (7) per accendere o spegnere la lampada frontale.

Fascia frontale

La lampada è dotata di una fascia frontale flessibile che si può allungare e regolare.

Dati tecnici

Sorgente luminosa 1	Striscia a LED (flex COB)
Sorgente luminosa 2	Spot a LED
Livello di luminosità	100% / 40% / lampeggiante
Alimentazione a batteria	1 batteria 1200 mAh Li-Po
Colore della luce	bianco
Luminosità	Striscia a LED: 300 lm Spot a LED: 90 lm
Durata di funzionamento	Striscia a LED: 2.5h Spot a LED: 4h
Materiale	ABS + silicone + EVA
Dimensioni	34x3.2x1.6 cm (LxWxH)
Peso	69 g

NOTE per la pulizia

- Prima di procedere con la pulizia, staccare l'apparecchio dalla sorgente di corrente!
- Pulire l'apparecchio soltanto con un panno asciutto. Non utilizzare liquidi detergenti per evitare danni ai componenti elettronici.

Dichiarazione di conformità CE

CE Bresser GmbH ha redatto una "dichiarazione di conformità" in linea con le disposizioni applicabili e le rispettive norme. Il testo completo della dichiarazione di conformità UE è disponibile al seguente indirizzo Internet:
www.bresser.de/download/9082600/CE/9082600_CE.pdf

SMALTIMENTO

 Smaltire i materiali di imballaggio in maniera differenziata. Le informazioni su uno smaltimento conforme sono disponibili presso il servizio di smaltimento comunale o l'Agenzia per l'ambiente locale.



Non smaltire gli apparecchi elettronici con i rifiuti domestici! Secondo la Direttiva Europea 2002/96/CE riguardante gli apparecchi elettrici ed elettronici usati e la sua applicazione nel diritto nazionale, gli apparecchi elettronici usati devono essere raccolti in maniera differenziata e destinati al riciclaggio ecologico.

Le batterie e gli accumulatori scarichi devono essere smaltiti

dall'utilizzatore negli appositi contenitori di raccolta. Le informazioni degli apparecchi o delle batterie usate prodotte dopo il 01.06.2006 sono disponibili presso il servizio di smaltimento o l'Agenzia per l'ambiente locale.

 Le batterie normali e ricaricabili devono essere correttamente smaltite come sta previsto dalla legge. È possibile tornare batterie inutilizzate presso il punto di vendita o cedere in centri di raccolta organizzati dai comuni per la raccolta gratuitamente.

Le batterie normali e ricaricabili sono contrassegnate con il simbolo corrispondente disposte per lo smaltimento e il simbolo chimico della sostanza inquinante. Per Esempio: „Cd“ sta per il cadmio, il „Hg“ sta per mercurio e „Pb“ per il piombo.



Cd¹



Hg²



Pb³

¹ Batteria contiene cadmio

² Batteria contiene mercurio

³ Batteria contiene piombo

Garanzia e assistenza

La durata regolare della garanzia è di 5 anni e decorre dalla data dell'acquisto. Le condizioni complete di garanzia e i servizi di assistenza sono visibili al sito www.bresser.de/warranty_terms.

ES Instrucciones de uso

Informaciones de carácter general



Lea atentamente las indicaciones de seguridad recogidas en este manual. Emplee este producto exclusivamente de la forma descrita en el manual, con el fin de evitar daños en el aparato o lesiones. Conserve el manual de instrucciones para poder volver a informarse en todo momento sobre las funciones de manejo.



Advertencias de carácter general

- PELIGRO DE DESLUMBRAMIENTO! Asegúrese de que personas y animales no miren directamente a la luz. Existe peligro de deslumbramiento y de imágenes retardadas por la gran luminosidad del dispositivo. Esta reducción de la facultad visual puede desencadenar accidentes.
- Use las lámparas LED a una distancia de al menos 20 cm.
- No mire la luz LED directamente durante un periodo prolongado de tiempo. El uso inadecuado de la linterna puede causar daños en los ojos. Existe peligro de ceguera por daños que se puedan causar en la retina ocular.
- ¡Existe PELIGRO DE ASFIXIA! – Mantener los materiales de embalaje (bolsas de plástico, bandas de goma) alejadas del alcance de los niños.
- Este aparato contiene componentes electrónicos que funcionan mediante una fuente de electricidad. No deje nunca que los niños utilicen el aparato sin supervisión. El uso se deberá realizar

de la forma descrita en el manual; de lo contrario, existe PELIGRO de DESCARGA ELÉCTRICA.

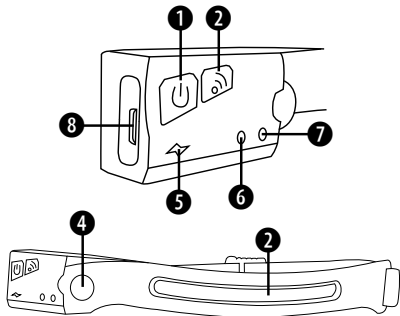

- ¡PELIGRO DE DESCARGA ELÉCTRICA! – No doblar, aplastar, estirar ni pasar por encima de cables de alimentación o conexión ni de alargadores o piezas de empalme. Proteja los cables de los bordes afilados y el calor excesivo. Antes de poner en funcionamiento, compruebe si presentan desperfectos el aparato, los cables y las conexiones.
¡No poner nunca en funcionamiento un aparato defectuoso o un aparato cuyas piezas conductoras de corriente presenten desperfectos! Es necesario recambiar sin demora las piezas defectuosas a través de una empresa de servicio técnico autorizada.
- ¡PELIGRO de daños materiales! – No desmonte el aparato. En caso de que exista algún defecto, le rogamos que se ponga en contacto con su distribuidor autorizado. Este se pondrá en contacto con el centro de servicio técnico y, dado el caso, podrá enviarle el aparato para su reparación.
- No exponga el aparato a altas temperaturas. ¡No cortocircuitar ni arrojar al fuego el aparato! El calor excesivo y el manejo inadecuado pueden provocar cortocircuitos, incendios e incluso explosiones.

Partes



- ❶ Botón de encendido/apagado, modos de funcionamiento
- ❷ Botón de sensor IR (encendido/apagado)
- ❸ Barra de LEDs
- ❹ Punto LED
- ❺ Indicador de funcionamiento
- ❻ Indicador de batería
- ❼ Sensor IR
- ❽ Puerto USB-C

Incluye





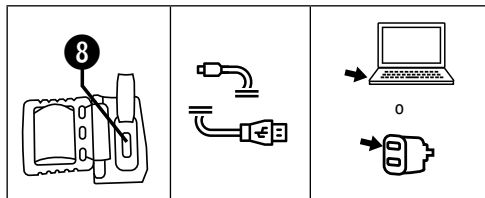

		
Linterna cabeza	Cable USB-C para cargar	Cinta para la cabeza



Carga por cable USB-C

El puerto USB-C le permite cargar la pila conectándose a un PC u otro puerto USB-C. Una luz roja parpadea cuando se está cargando. Una luz roja (6) se enciende cuando la batería está en carga.



Modos de funcionamiento ①

 Pulsar	Función
	<ul style="list-style-type: none"> • Encender linterna • Barra de LEDs al 100%
	<ul style="list-style-type: none"> • Barra de LEDs al 40%
	<ul style="list-style-type: none"> • Punto de LEDs al 100%
	<ul style="list-style-type: none"> • Punto de LEDs al 40%
	<ul style="list-style-type: none"> • Luz flash (SOS)
	<ul style="list-style-type: none"> • Apagar linterna

 Pulsar	Función
	<ul style="list-style-type: none"> • Activar sensor IR
	<ul style="list-style-type: none"> • Desactivar sensor IR

Sensor IR

Seleccione primero el modo de funcionamiento deseado pulsando el botón de modo de funcionamiento (1). Ahora active el modo de sensor IR pulsando el botón de sensor IR (2). Cuando el indicador de funcionamiento (5) se ilumina en rojo/verde, el modo de sensor IR está activado. Mantenga su mano a unos 15 cm delante del sensor IR (7) de la linterna para encender o apagar la luz.

Cinta para cabeza

La linterna incluye una cinta elástica y ajustable.

Datos técnicos

Fuente de luz1	Barra LED (flex COB)
Fuente de luz 2	Punto LED
Niveles de brillo	100% / 40% / flashes
Batería	1x 1200 mAh batería Li-Po
Color de luz	blanco
Brillo	Barra LED : 300 lm Punto LED : 90 lm
Horas de funcionamiento	Barra LED : 2.5h Punto LED : 4h
Material	ABS + Silicona + EVA
Dimensiones	34x3.2x1.6 cm (LxAxH)
Peso	69 g

NOTAS sobre la limpieza

- Antes de limpiar el aparato, desconéctelo de la fuente de electricidad.
- Limpie solamente el exterior del aparato con un paño seco. No utilice productos de limpieza para evitar daños en el sistema electrónico.

Declaración de conformidad de la Unión Europea (CE)

 Bresser GmbH ha emitido una "Declaración de conformidad" de acuerdo con las directrices y normas correspondientes. El texto completo de la declaración de conformidad de la UE está disponible en la siguiente dirección de Internet: www.www.bresser.de/download/9082600/CE/9082600_CE.pdf

ELIMINACIÓN

 Elimine los materiales de embalaje separados por tipos. Obtendrá información sobre la eliminación reglamentaria en los proveedores de servicios de eliminación municipales o en la agencia de protección medioambiental.

 ¡No elimine los electrodomésticos junto con la basura doméstica! Conforme a la directiva europea 2002/96/UE sobre aparatos eléctricos y electrónicos usados y a su aplicación en la legislación nacional, los aparatos eléctricos usados se

deben recoger por separado y conducir a un reciclaje que no perjudique al medio ambiente. Las pilas y baterías descargadas deben ser llevadas por los consumidores a recipientes de recogida para su eliminación. En los proveedores de servicios de eliminación municipales o en la agencia de protección medioambiental podrá obtener información sobre la eliminación de aparatos o pilas usados fabricados después del 01-06-2006.

 De acuerdo con la normativa en materia de pilas y baterías recargables, está explícitamente prohibido depositarlas en la basura normal. Por favor, preste atención a lo que la normativa obliga cuando usted quiera deshacerse de estos productos - sobre puntos de recogida municipal o en el mercado minorista (disposición sobre violación de la Directiva en materia de los residuos domésticos- pilas y baterías-). Las pilas y baterías que contienen productos tóxicos están marcados con un signo y un símbolo químico.

Cd¹Hg²Pb³

- 1 pila que contiene cadmio
- 2 pila que contiene mercurio
- 3 pila que contiene plomo

Garantía y servicio

El período regular de garantía es 5 años iniciándose en el día de la compra. Las condiciones de garantía completas y los servicios pueden encontrarse en www.bresser.de/warranty_terms.

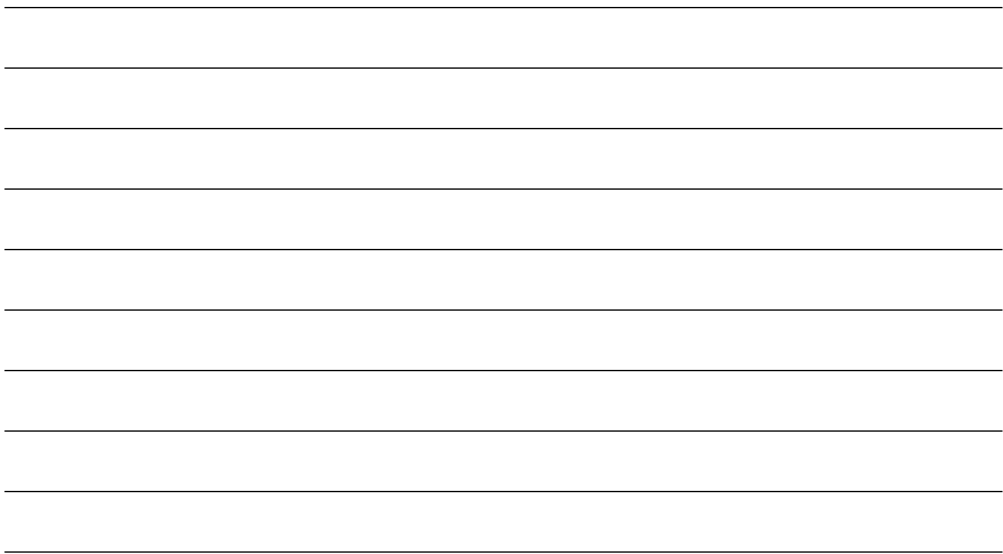



YOUR PURCHASE HAS PURPOSE

Every purchase helps support the global nonprofit National Geographic Society in its work to protect and illuminate our world through exploration, research, and education.

TO LEARN MORE, VISIT NATGEO.COM/INFO

© National Geographic Partners LLC.
All rights reserved. NATIONAL GEOGRAPHIC and Yellow Border Design are trademarks of National Geographic Society, used under license.

Visit our website: www.nationalgeographic.com



Bresser GmbH
Gutenbergstr. 2
46414 Rhede
Germany

www.bresser.de • info@bresser.de

Bresser UK Ltd.
Suite 3G, Eden House
Enterprise Way, Edenbridge,
Kent TN8 6HF, Great Britain

Irrtümer und technische Änderungen vorbehalten. • Errors and technical changes reserved.